

ESBE SERIES CRA, CRB, CRC

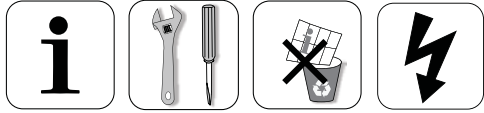

Series CRA110
Series CRB100
Series CRC110

CE
LVD 2006/95/EC
EMC 2004/108/EC
RoHS 2011/65/EC

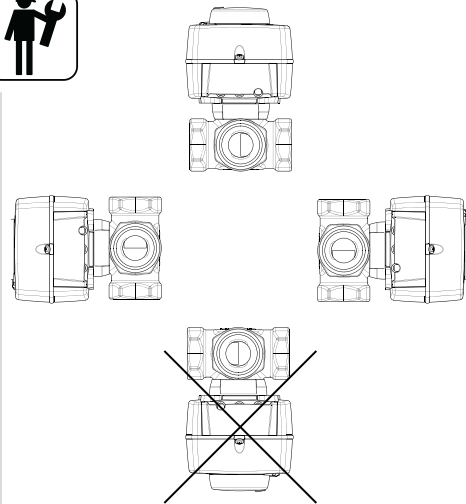
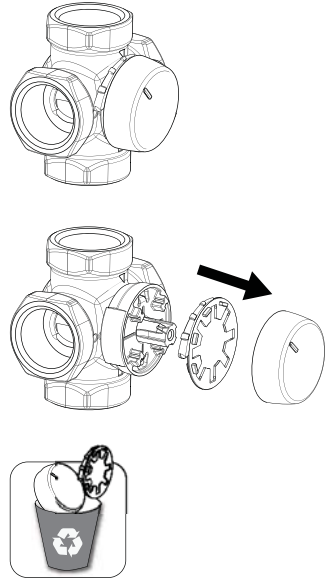
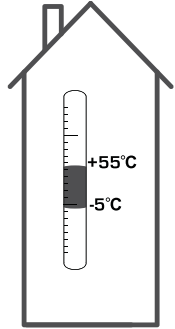

MG, G, F, H, HG, BIV, T, TM

	DN15-25	
	DN20-40	
	DN50	
	DN20-25	
	DN32-50	
	H: DN25	
	H: DN32-50	
	HG: DN25	
	DN20-22	
	DN25	
	T: DN20-32	
	TM: DN20	

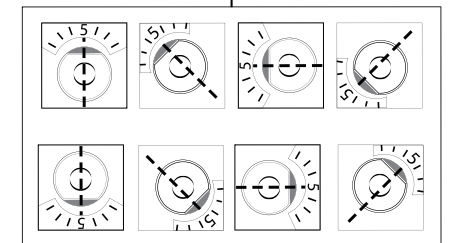
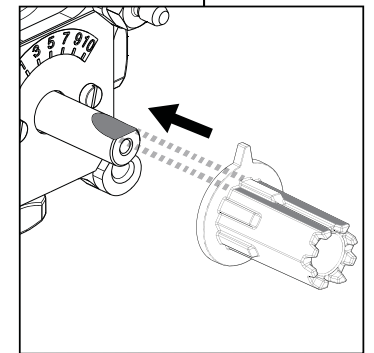
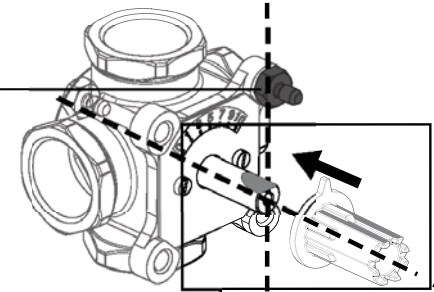

CRA110, CRB100, CRC110



VRG130, VRG140, VRG230, VRB140



3MG, 4MG



3G, 4G



3F, 4F ≤ DN50



3HG, 4HG, 3H, 4H



BIV



T, TM

**VRG130, VRG140,
VRG230, VRB140**

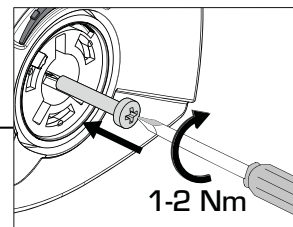
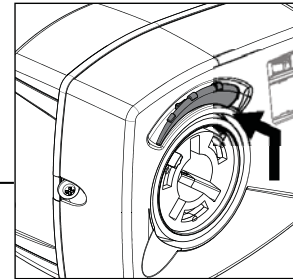
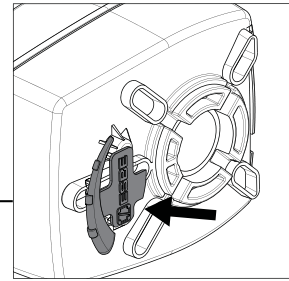
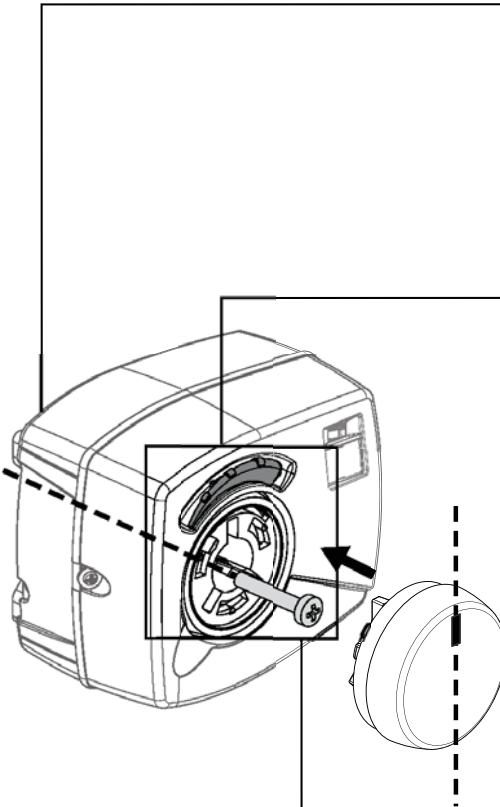
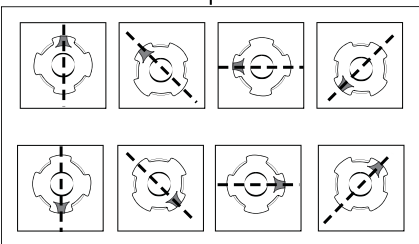
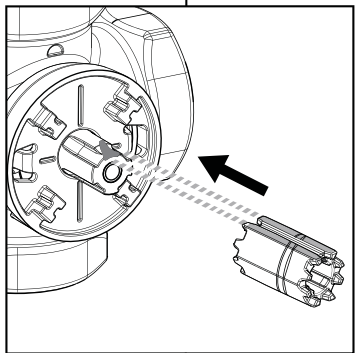
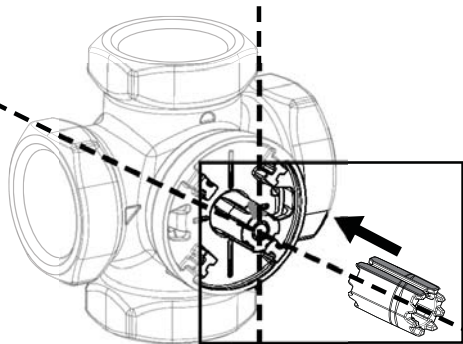

www.esbe.se

Mtrl.nr: 98140403 • Ritn.nr: 8308 utg. C • Rev. 1305

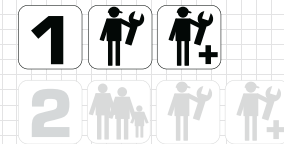

**SERIES
CRA110, CRB100, CRC110**



NO.1 IN HYDRONIC SYSTEM CONTROL

SERIES VRG130

a

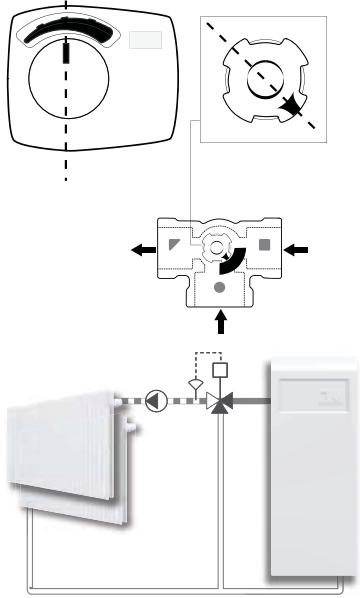

b

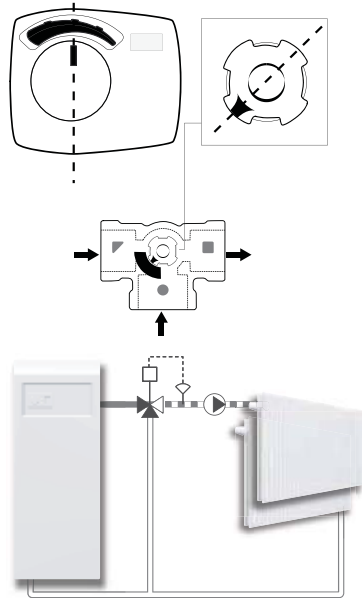

c

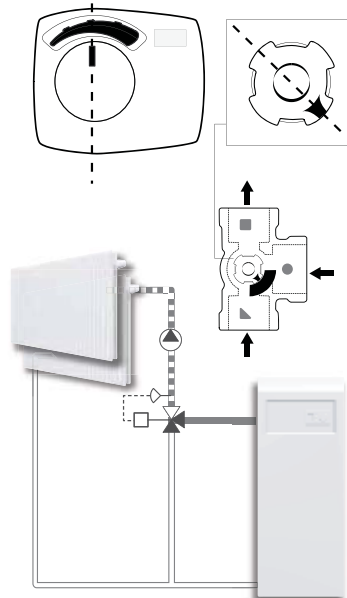

d

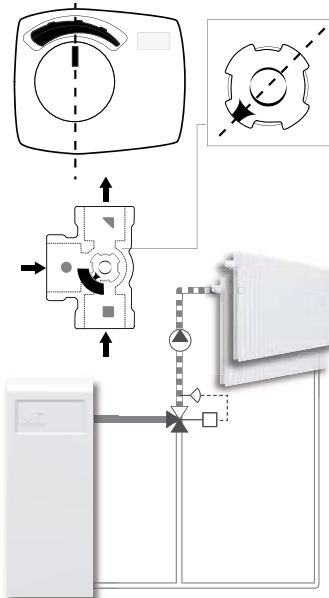

e

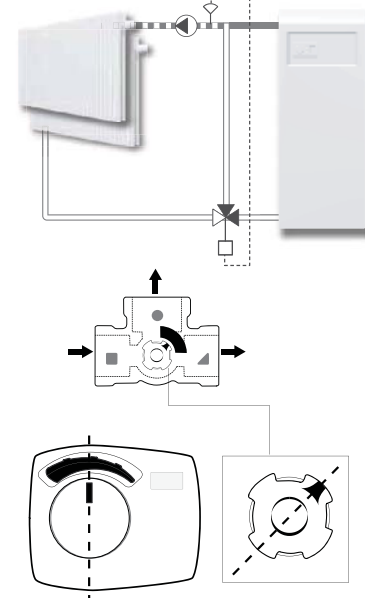

k

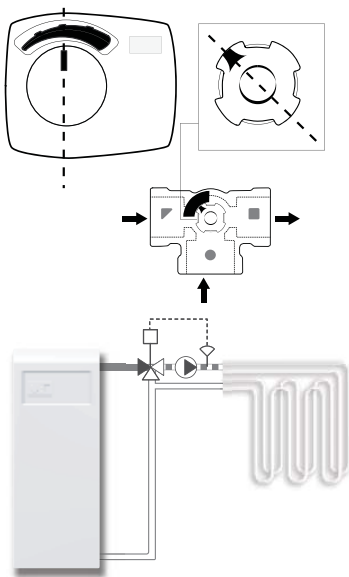

l

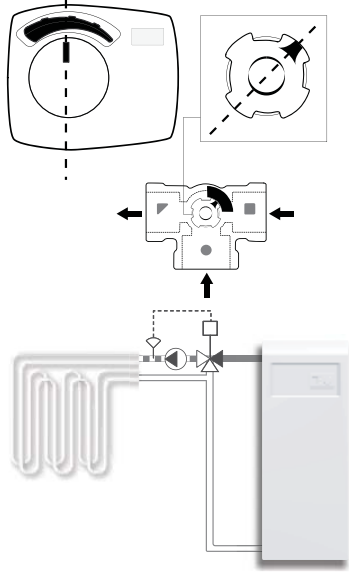

m

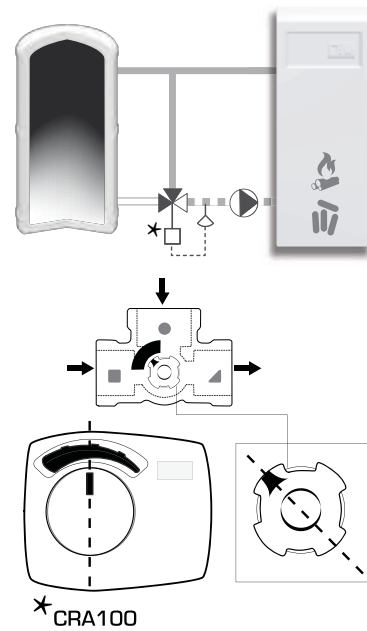

n

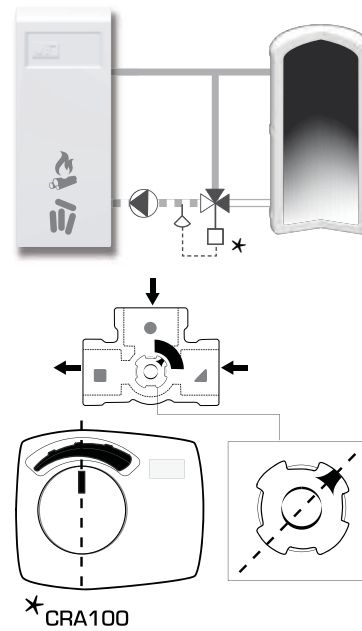

o

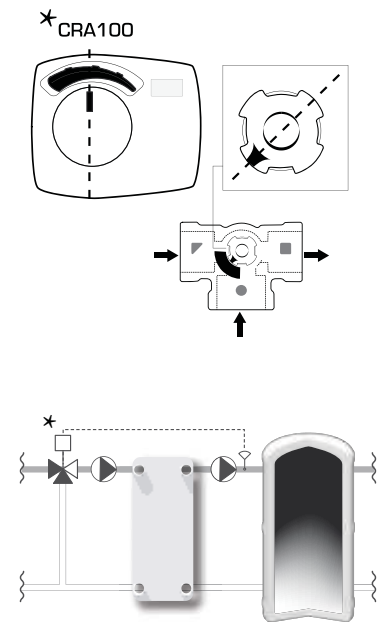

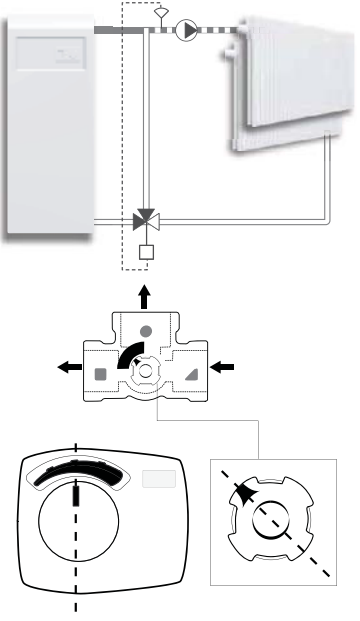
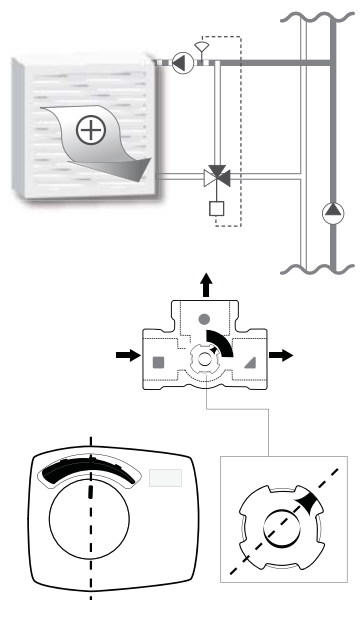
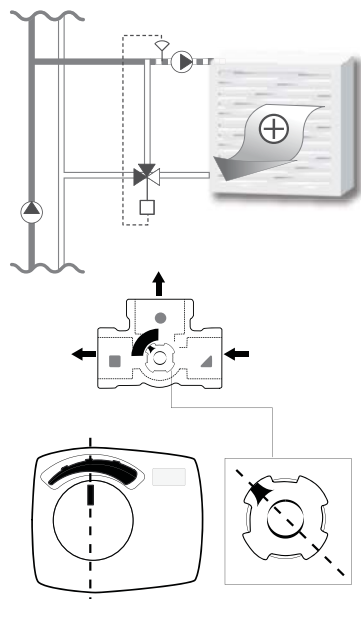
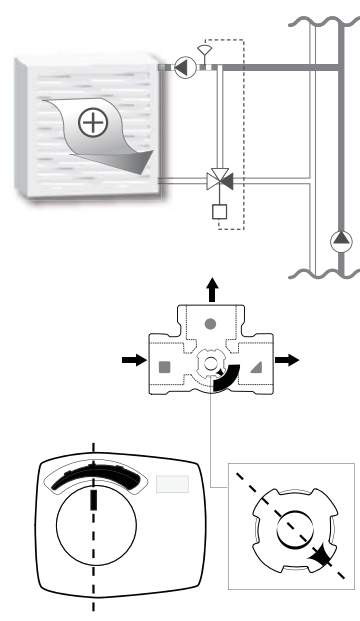
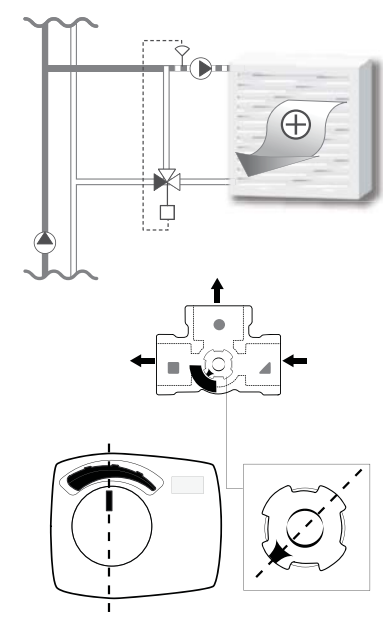
f**g****h****i****j**

SERIES VRG130

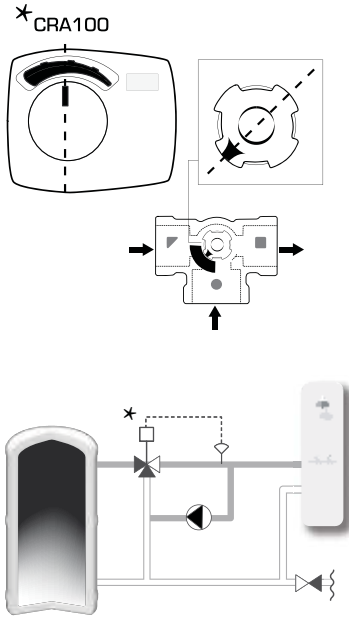
p

SERIES VRG130

SERIES VRG140

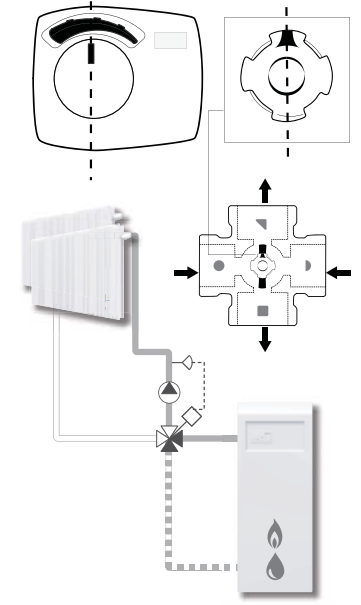
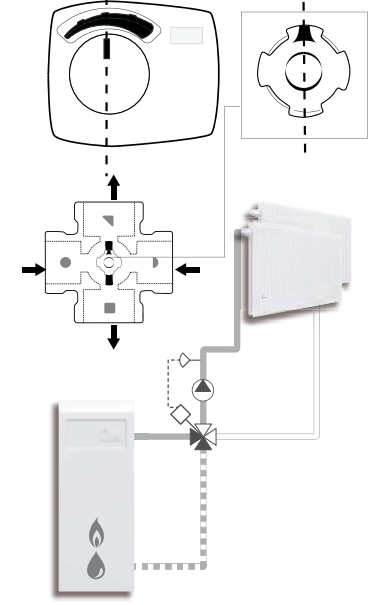
a**b**

SERIES VRG230

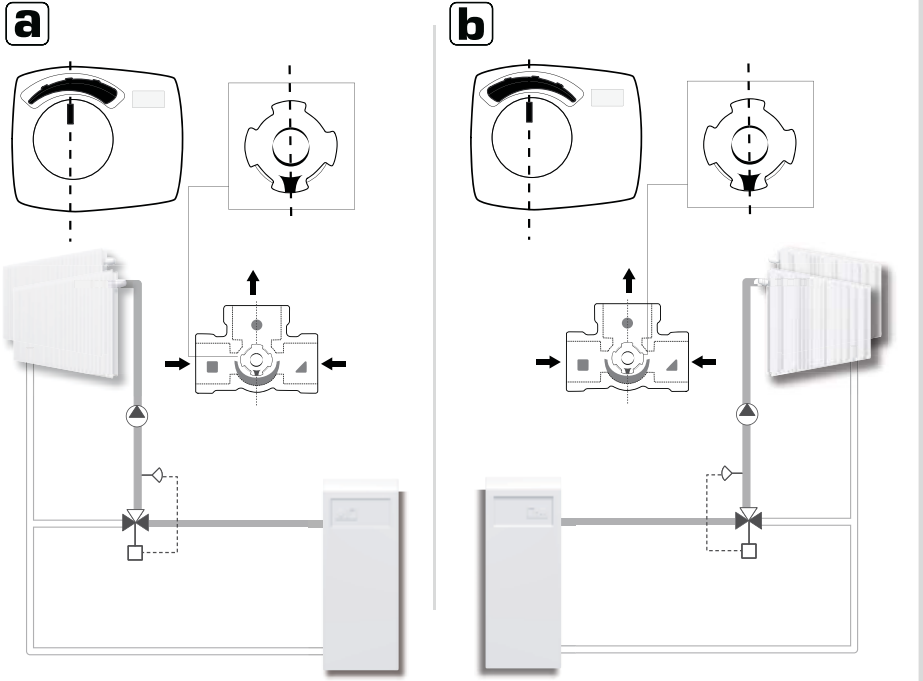

SERIES VRG330

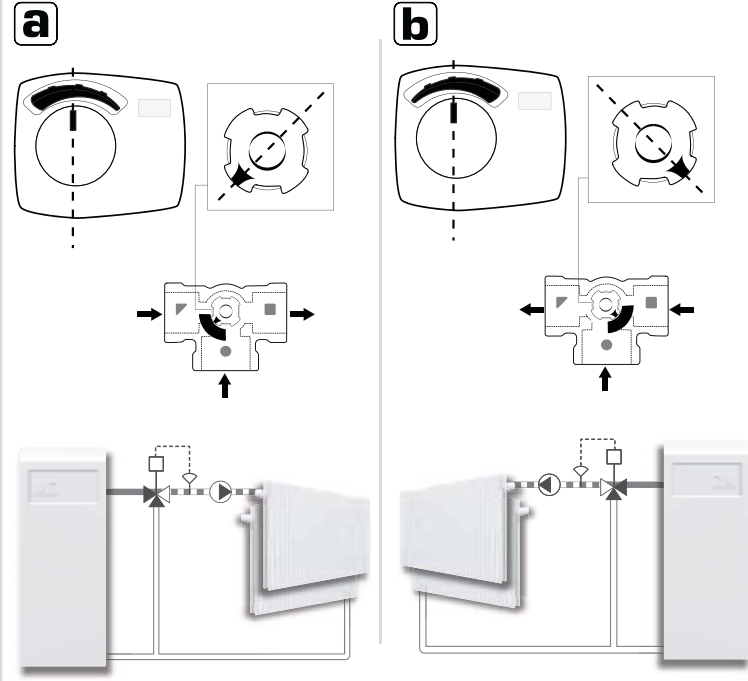

SERIES VRB140

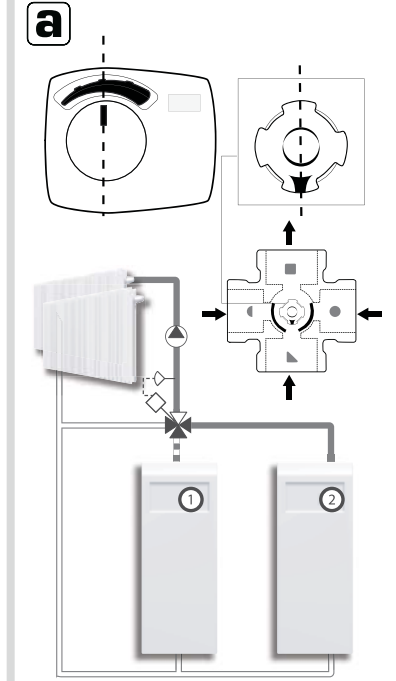

SERIES BIV

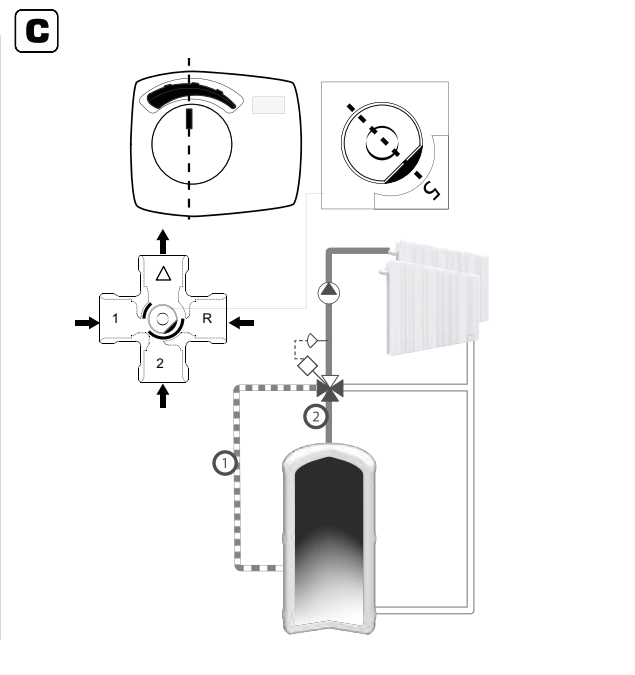
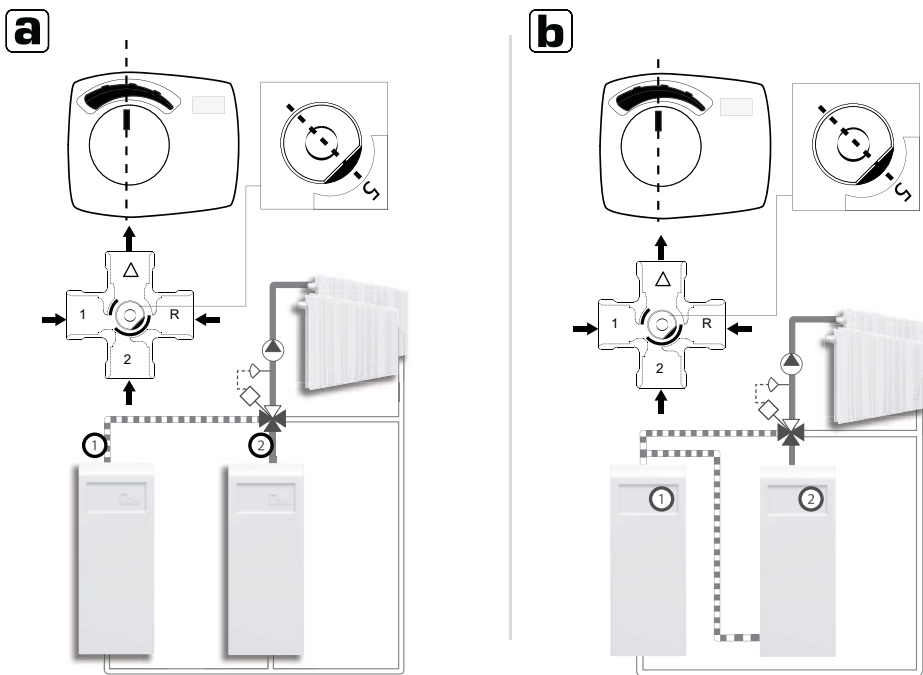

We would like to point out to the existence of a German patent, DE 19821256C5 affecting the usage of bivalent 4-way valves in liquid circulation heating systems. In this patent the usage of a 4-way bivalent valve in a type of heating system is protected, in which 2 different heating circuits are operated in parallel, where the return of the first circuit is utilized as heat source for the second circuit. The floor heating is heated through the heat source and the return from the primary heat circuit is utilized as alternative secondary heat source for the floor heating. Such a utilization of our bivalent 4-way valve without approval of the patent holder is forbidden. All other applications our product group VRB are without reservations possible.

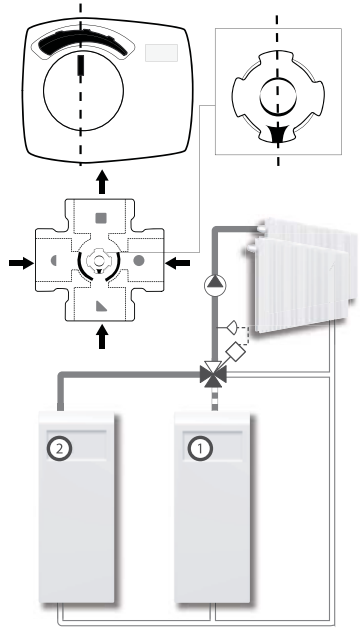
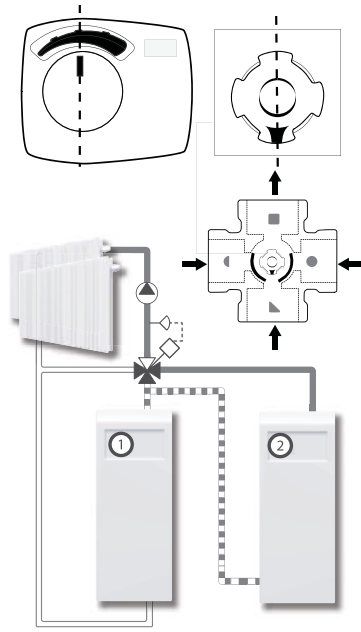
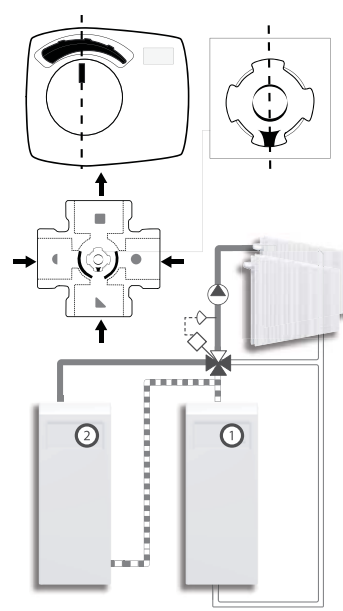
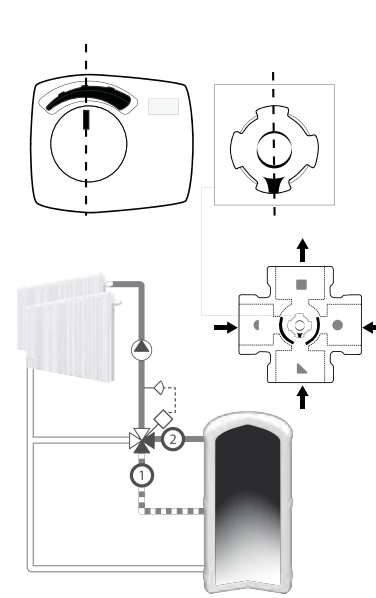
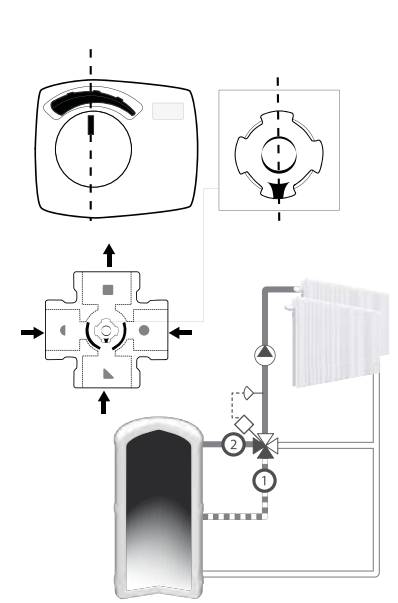
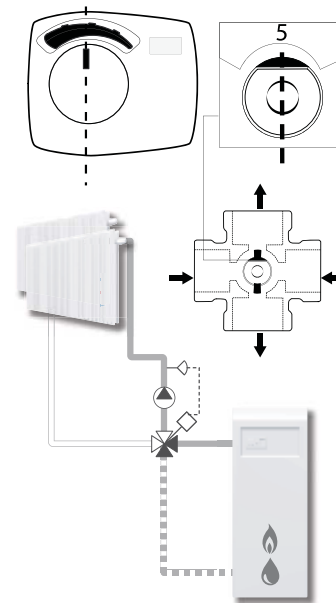
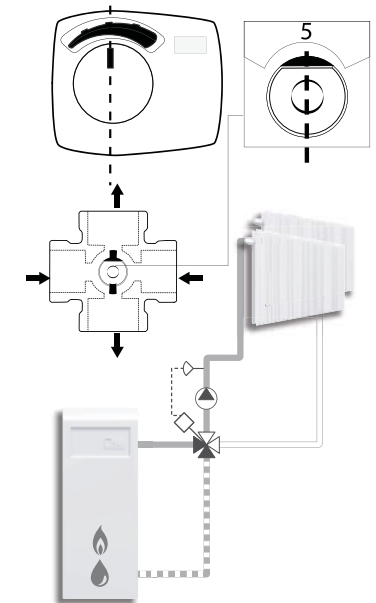
b**c****d****e****f****SERIES VRB140****SERIES 4F, 4MG, 4G****a****b**

SERIES 3F, 3MG, 3G

a

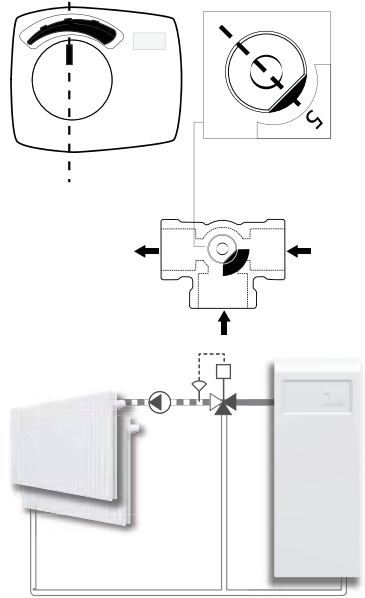

b

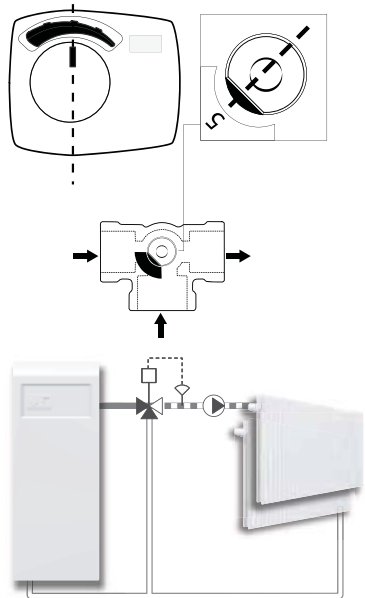

c

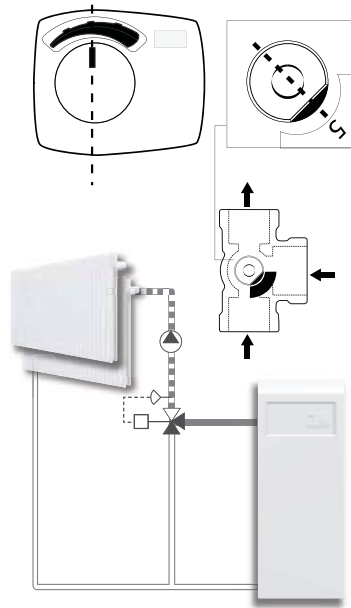

d

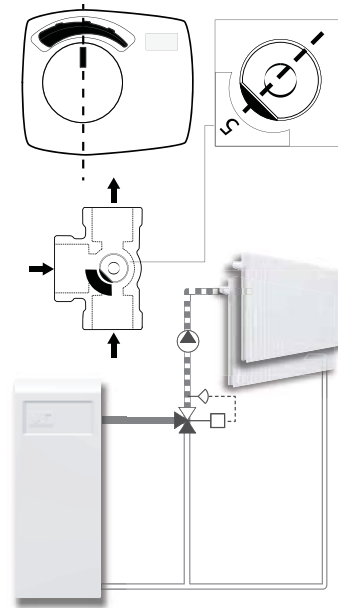

e

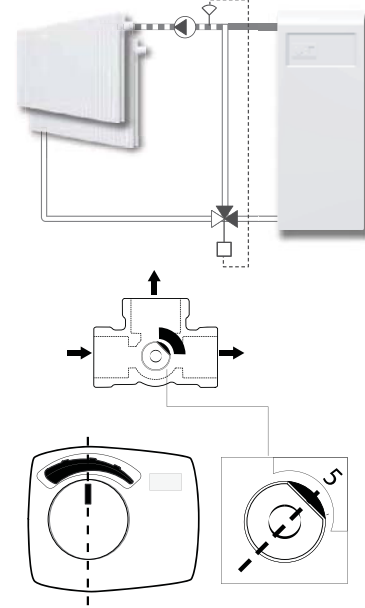

k

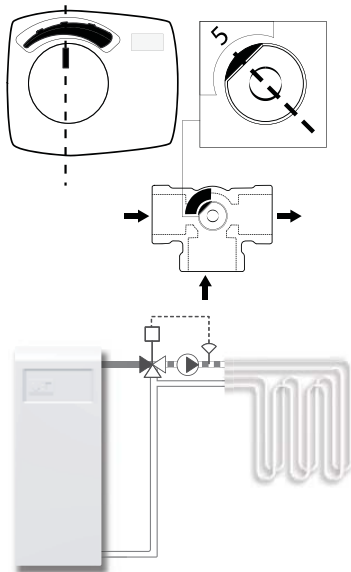

l

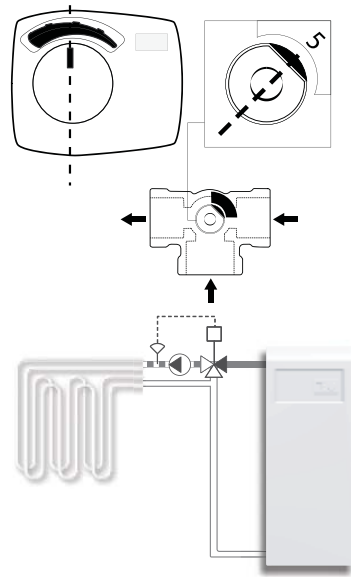

m

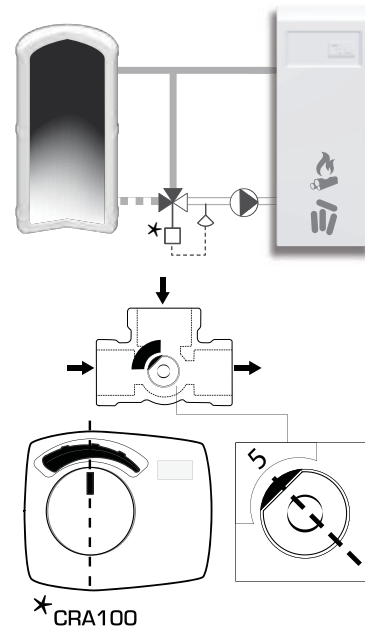

n

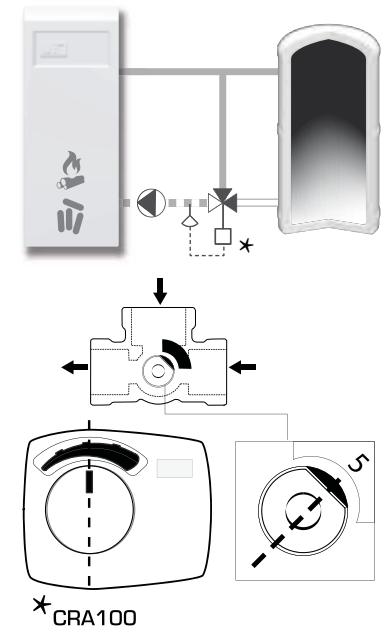

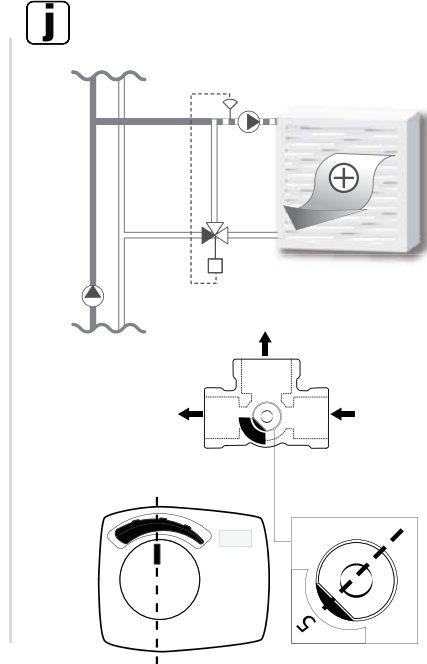
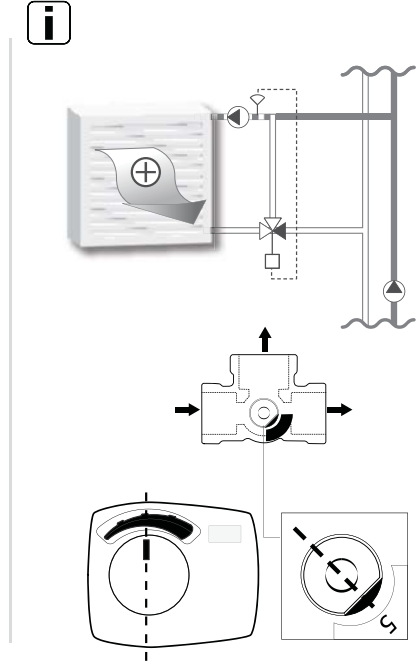
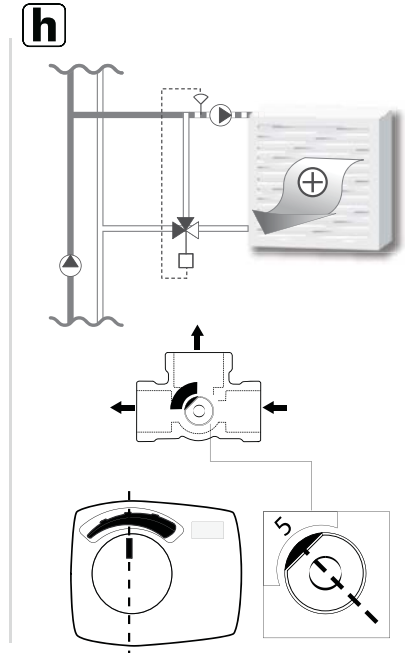
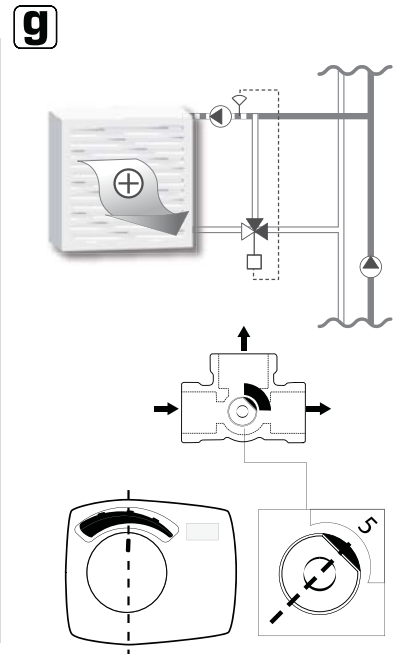
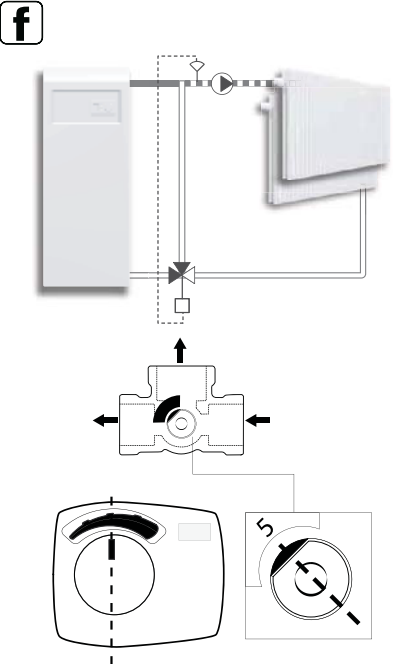

SERIES 3F, 3MG, 3G

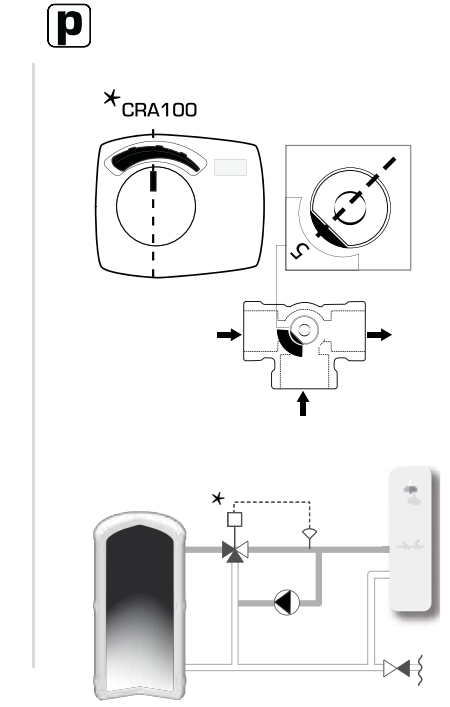
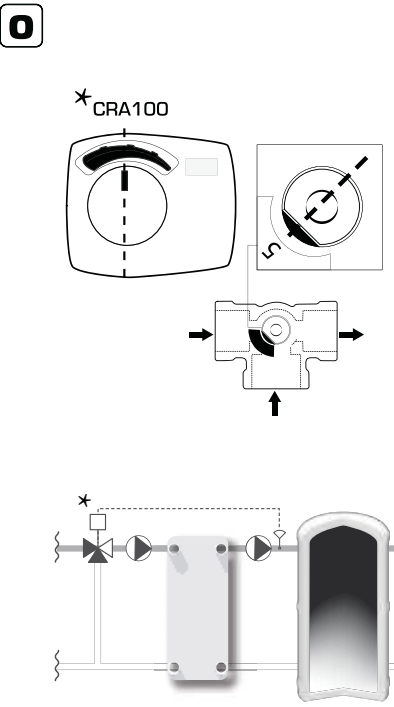

SERIES 3F, 3MG, 3G

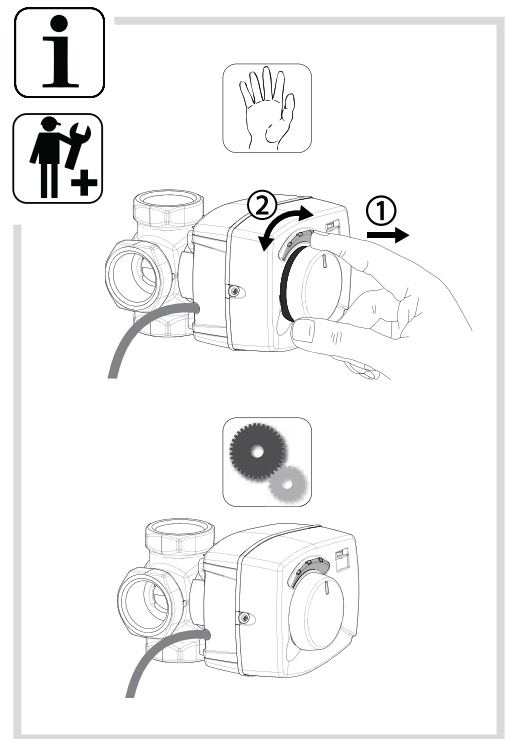

Piping Schematics are General Representations